



# Robotayaki RM SE 60



## FEATURES

### WHAT IS A ROBATAYAKI?

Inspired by the centuries-old Japanese style of cooking Robotayaki, or often known as Robata, we have created the new Mibrasa® Robotayaki.

A multi-tier open charcoal grill equipped with accessories to perform a range of cooking techniques using grills, Teppanyaki hot plates or skewers. Robata grilling lends to an array of foods from meat, fish, seafood and vegetables, imparting light smoky aromas and flavors we seek in grill cooking.

Originating from the Japanese tea ceremony, which overtime found its way to the north Japanese fishermen utilizing this method to keep food hot while out at sea for long periods. The evolution of the Robotayaki has brought it into the modern kitchen, where chefs prepare the food and display their showmanship in front of diners allowing them to take part in the entire cooking experience.

### QUALITY AND CONSTRUCTION

The Mibrasa® Robotayaki is manufactured with steels of the latest technology following the most rigorous quality controls.

## TECHNICAL INFORMATION

Fire up time <sup>1</sup>	30 min-average
Cooking temperature	482 °F
	250 °C
Initial charcoal load <sup>1</sup>	7 lb
	3 kg
Charcoal load duration <sup>2</sup>	5 h
Equivalent power*	2 hp
	1.5 kW
Exhaust rate	161 gal/s
	2200 m <sup>3</sup> /h
Installation height*	31.50 in
	800 mm
Max. no. grills/level	1
Net weight <sup>3</sup>	229 lb
	104 kg

## GRILL DIMENSIONS

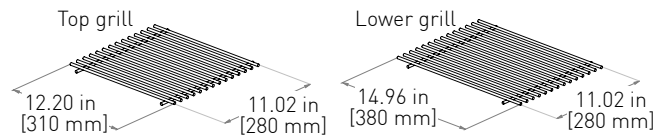

\*Approximate data  
 1. Consult instruction manual  
 2. Will vary depending on quality of charcoal  
 3. Weight with accessories included

## INCLUDED ACCESSORIES

- Top grill
- Lower grill
- Support bars (4)
- Ember poker
- Ash shovel
- Mibrasa tongs
- Grill brush
- Mibrasa Ecofire fire-lighters

## OPTIONAL ACCESSORIES

- Top mesh grill
- Lower mesh grill
- Support bars (2)
- Flat top Teppanyaki griddle
- Perforated Teppanyaki griddle
- Robotayaki stand
- Robotayaki drop-leaf stand
- Lid for end of service
- Stainless steel skewers 30 cm

Specifications and design are subject to change without notice.

## QUALITY GUARANTEE





# Robatayaki RM SE 60

**FRONT VIEW**

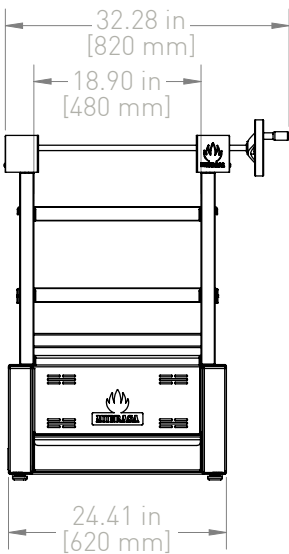

**SIDE VIEW**

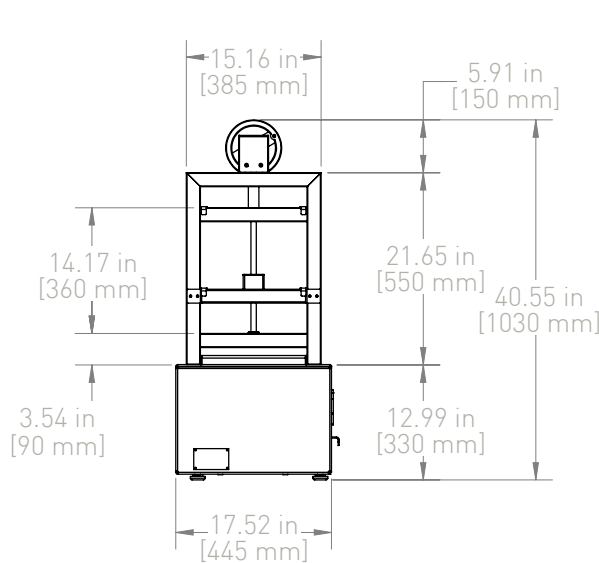

**TOP VIEW**

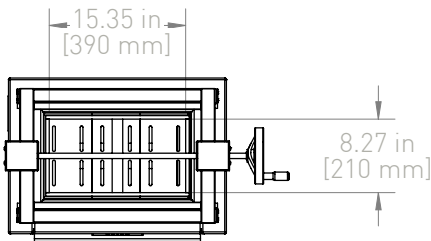

**RM SE (Mibrasa Robatayaki with elevating system)**

With an incorporated elevating system, designed and patented by Mibrasa® enabling height adjustments between the grill and hot coals to provide the chef with total control allowing them to cook with more efficiency.

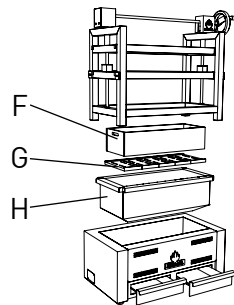
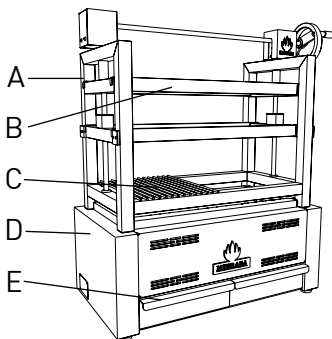

A	SE Structure
B	SE Support bars
C	Grill
D	Main body
E	Ash collector
F	Burning pit
G	Charcoal grids
H	Interior body

**GRILL TYPES**

Grill

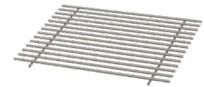

Mesh grill

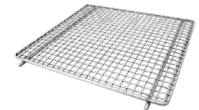

Flat top Teppanyaki griddle



Perforated Teppanyaki griddle

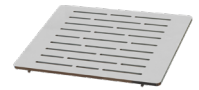

**SHIPMENT**

- Crated weight: 328 lb [149 kg]
- Crated size (WxDxH): 27.6 x 21.6 x 47.2 in [700 x 550 x 1200 mm]

Revit drawings available on request at [usa@mibrasa.com](mailto:usa@mibrasa.com)

**Installation guidelines and safety standards**

- Combustible floor protection dimensions:
  - a. 30 in [762 mm] to each side of the Robatayaki
  - b. 36 in [914 mm] in front of Robatayaki
- Clearances to combustible constructions
  - a. Unit to backwall = 18 in [457 mm]
  - b. Unit to sidewalls = 28 in [711 mm]
- The workspace for the chef should be 27.56 in [700 mm] from the front of the Robatayaki.
- A lifting device should be used whenever possible to lift the Robatayaki and place on the countertop/stand.

For further information, please consult the instruction manual.

Specifications and design are subject to change without notice.