



IMMERSION CIRCULATOR SMARTVIDE 9

Max. capacity: 56 lt./14 gal.



SALES DESCRIPTION

Commercial high-precision sous-vide cooker. Reliable, user-friendly, portable.

Interchangeable between °C and °F.

- ✓ Bluetooth connectivity.
- ✓ HACCP-ready.
- ✓ Optional core probe.
- ✓ Firmware update.

FEATURES AND BENEFITS

Portable precision cooker with stirrer for up to 56 lt. / 14 gal. containers. Designed for chefs, developed with chefs.

- ✓ The thick stainless steel, robust construction guarantees commercial performance.
- ✓ SmartVide guarantees cooking at a **precisely controlled temperature** while preserving the quality of the product, enhancing flavour and texture. Equipped with a highly precise temperature control system to obtain extremely consistent results. An **optional core probe** allows getting an even more precise control.
- ✓ Allows cooking food in their own juice and using this juice immediately after cooking to **enhance flavours**.
- ✓ Marinates and macerates an ingredient in **half the time**.
- ✓ **Infuses and flavours** oil, fat or other products applying the controlled temperature technique.
- ✓ Increases **profits** due to lack of product shrink.
- ✓ Requires **very little hands-on time**, allowing the Chef to do other tasks while the product is being cooked. Just program temperature and time, SmartVide will do the rest. 4 buttons and a full-colour TFT display that offers **all the information at a glance** makes operation a child's play. Moreover, thanks to Bluetooth connectivity, SmartVide 8 Plus allows for an interchange of important data to improve the chef's performance.
- ✓ **Portable:** thanks to their thick, stainless steel, ergonomic handle, SmartVide9 can be taken from a container to another easily. Additionally, the bag supplied with the circulator allows easy transport - wherever the Chef goes.
- ✓ **HACCP-ready:** thanks to Bluetooth connectivity, it is possible to export or print cooking results at the end of each cycle.
- ✓ **Your appliance, always updated:** free firmware update, no matter where the appliance is.

INCLUDES

- ✓ Transport bag.

ACCESSORIES

- Core probe.
- Insulated tank.
- Lid for insulated tank.
- Floating balls.



sammic | www.sammic.com
Food Service Equipment Manufacturer

Polígono Basarte, 1. phone +34 943 15 72 36
20720 Azkoitia, Spain sales@sammic.com



Project	Date
Item	Qty
Approved	

FOOD PRESERVATION AND SOUS-VIDE
SOUS-VIDE COOKERS

product sheet
updated 21/11/2019



IMMERSION CIRCULATOR SMARTVIDE 9

Max. capacity: 56 lt./14 gal.



SPECIFICATIONS

Temperature

Display precision: 0.01 °C

Range: 5 °C - 95 °C

Permissible ambient temperature: 5 °C - 40 °C

Time

Resolution: 1 '

Cycle duration: 1 ' - 99 h

General features

Maximum recipient capacity: 56 l

Total loading: 2000 W

Submersible part dimensions: 117 mm x 110 mm x 147 mm

External dimensions (WxDxH): 124 mm x 140 mm x 360 mm

Net weight: 4.2 Kg

Crated dimensions

440 x 190 x 310 mm

Gross weight: 5.8 Kg.

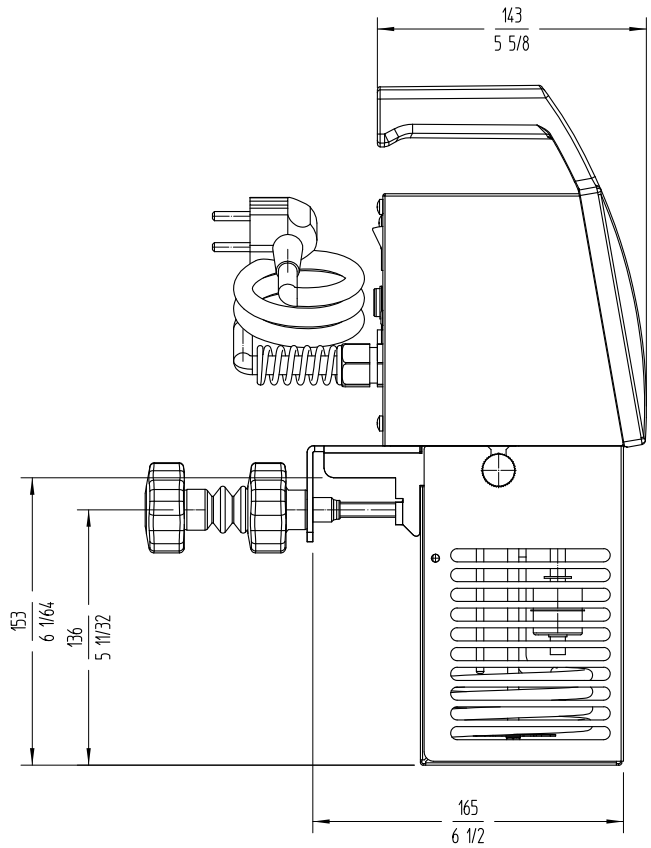
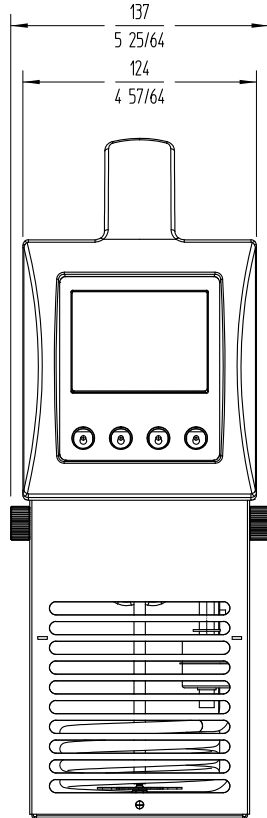

AVAILABLE MODELS

1180141 SmartVide 9 230/50-60/1 UK

1180143 SmartVide 9 120/60/1

1180140 SmartVide 9 230/50-60/1

* Ask for special versions availability

sammic | www.sammic.com
Food Service Equipment Manufacturer

Polígono Basarte, 1. phone +34 943 15 72 36
20720 Azkoitia, Spain sales@sammic.com



Project	Date
Item	Qty
Approved	

FOOD PRESERVATION AND SOUS-VIDE
SOUS-VIDE COOKERS

product sheet
updated 21/11/2019